

FIG. 1

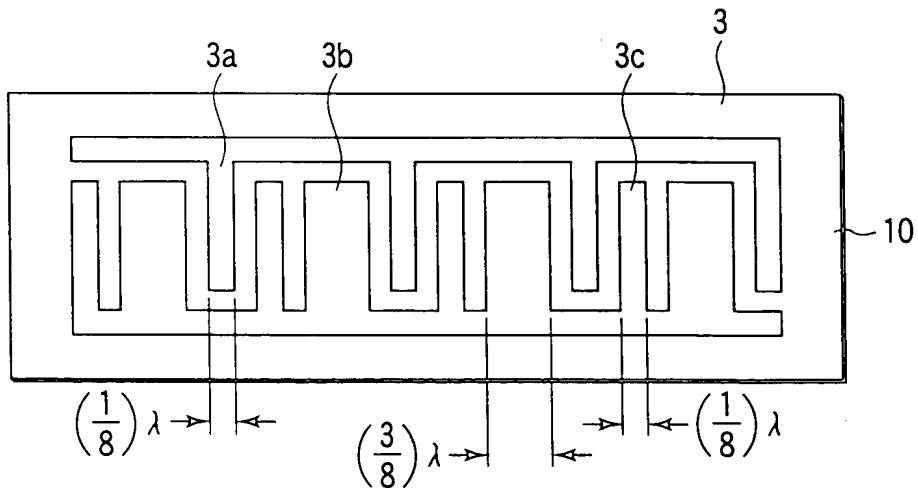

FIG. 2

RESONANCE FREQUENCY	F11	F12	Fc2	Fc1	Fu1	Fu2
PHASE RELATIONSHIP (SIGN)	+	-	+	-	+	-

FIG. 3

RESONANCE FREQUENCY	F11	F12	Fc2	Fc1	Fu1	Fu2
PHASE RELATIONSHIP (SIGN)	-	+	-	+	-	+

FIG. 4

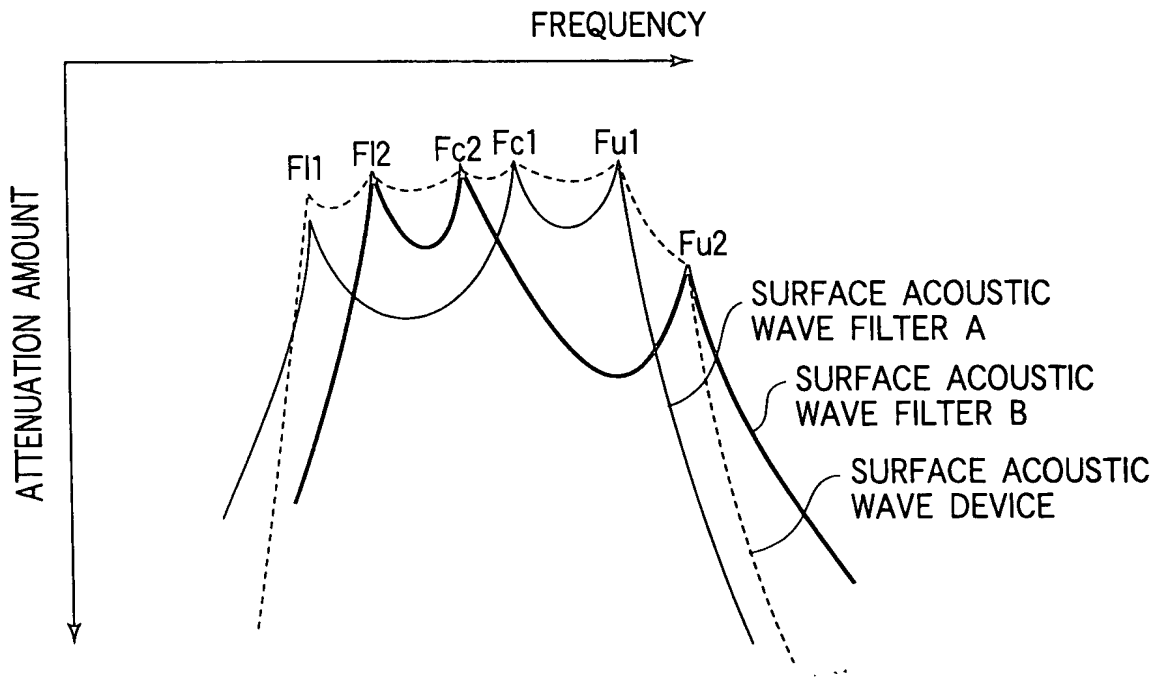

FIG. 5

F0050-EST-660

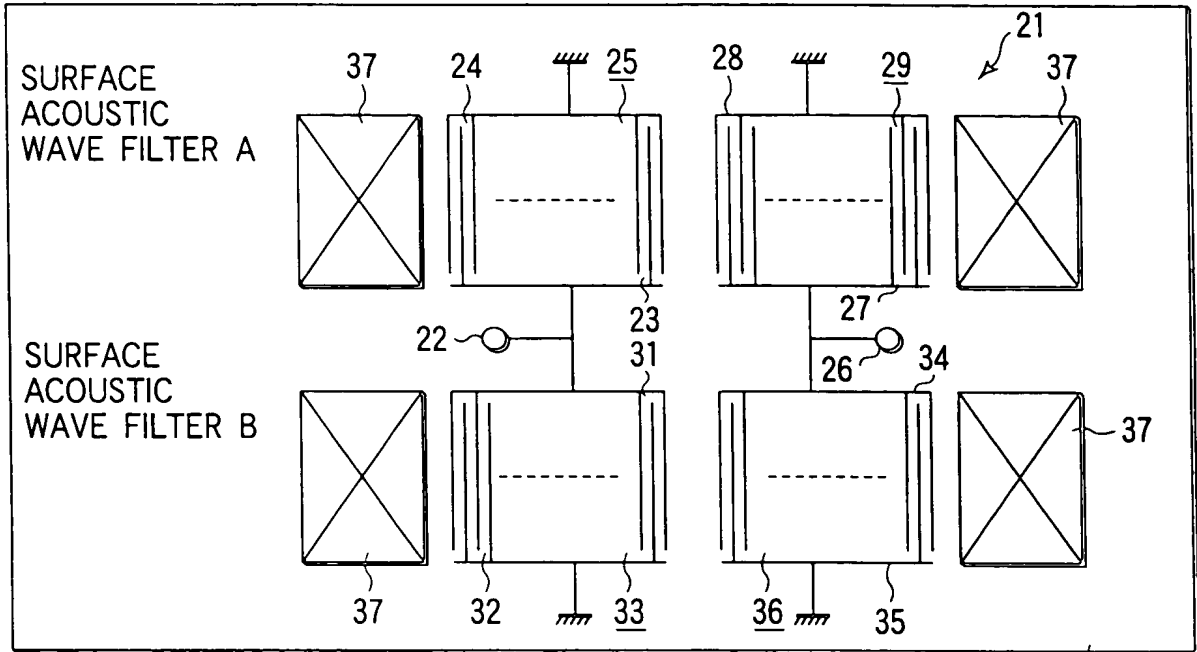

FIG. 6

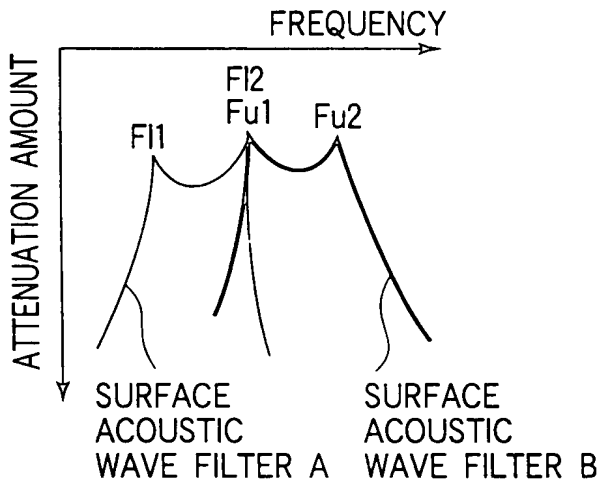

FIG. 7

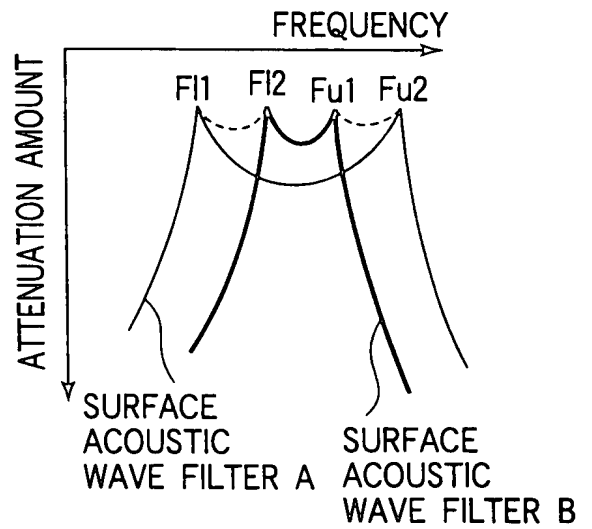

FIG. 8

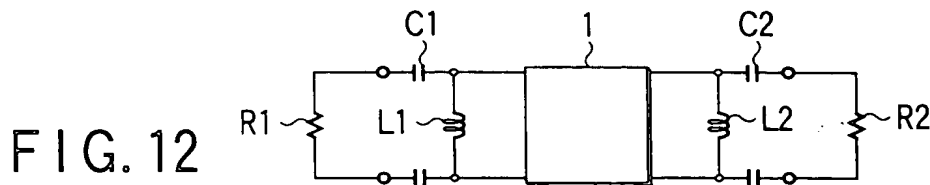
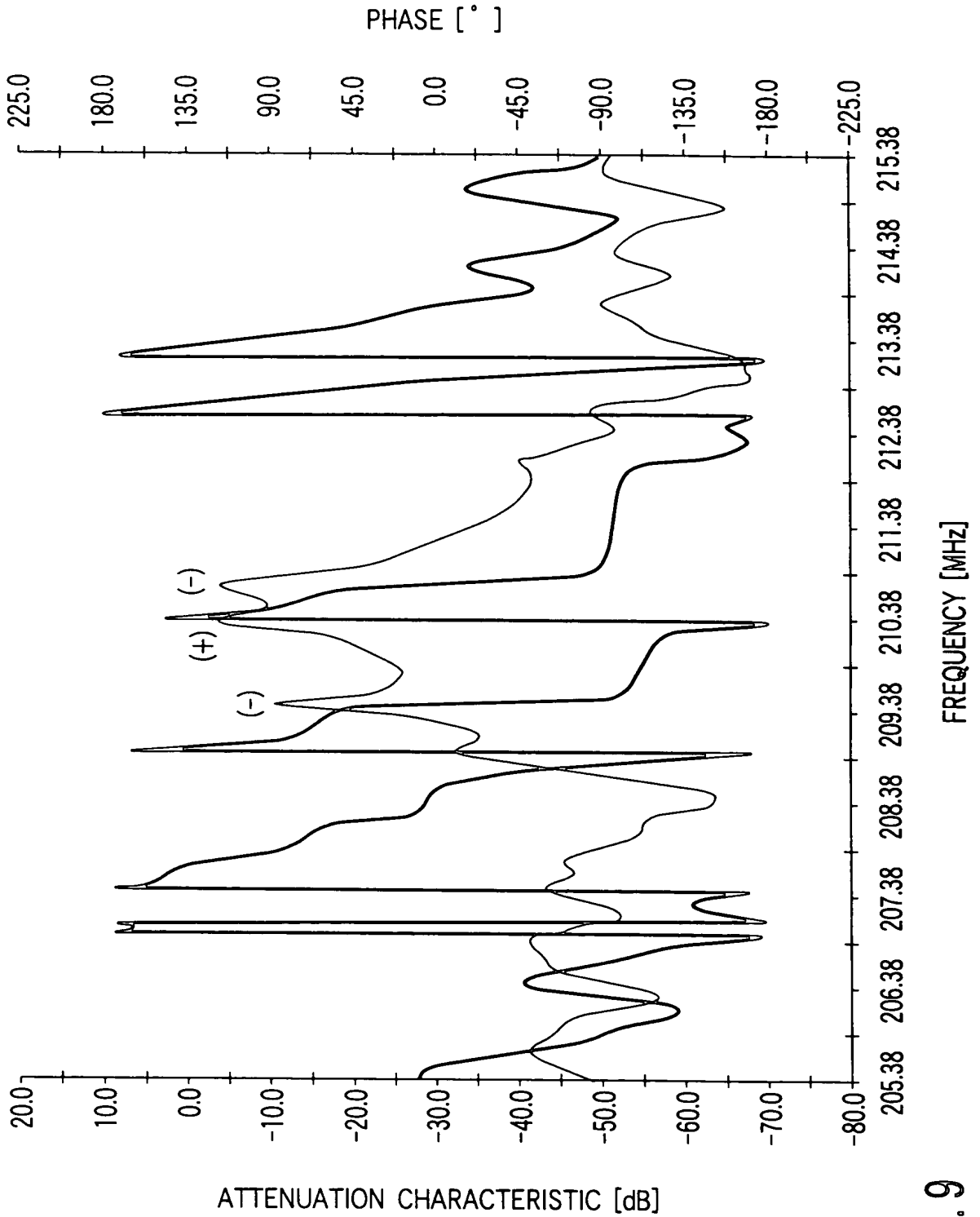

FIG. 12

FIG. 9 208526US-2S



4/8



101030*E80F660

FIG. 9

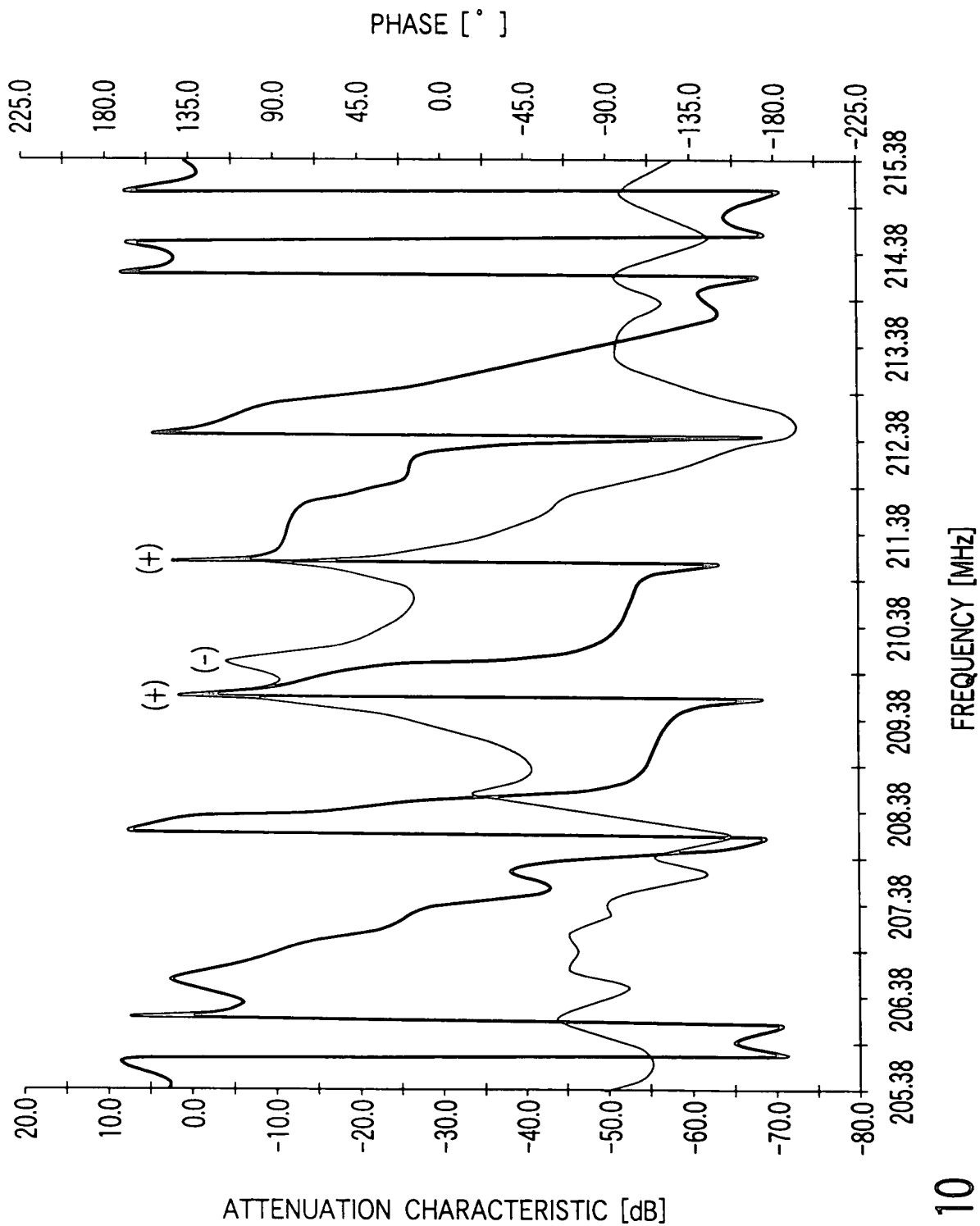

FIG. 10

208526US-2S CONT

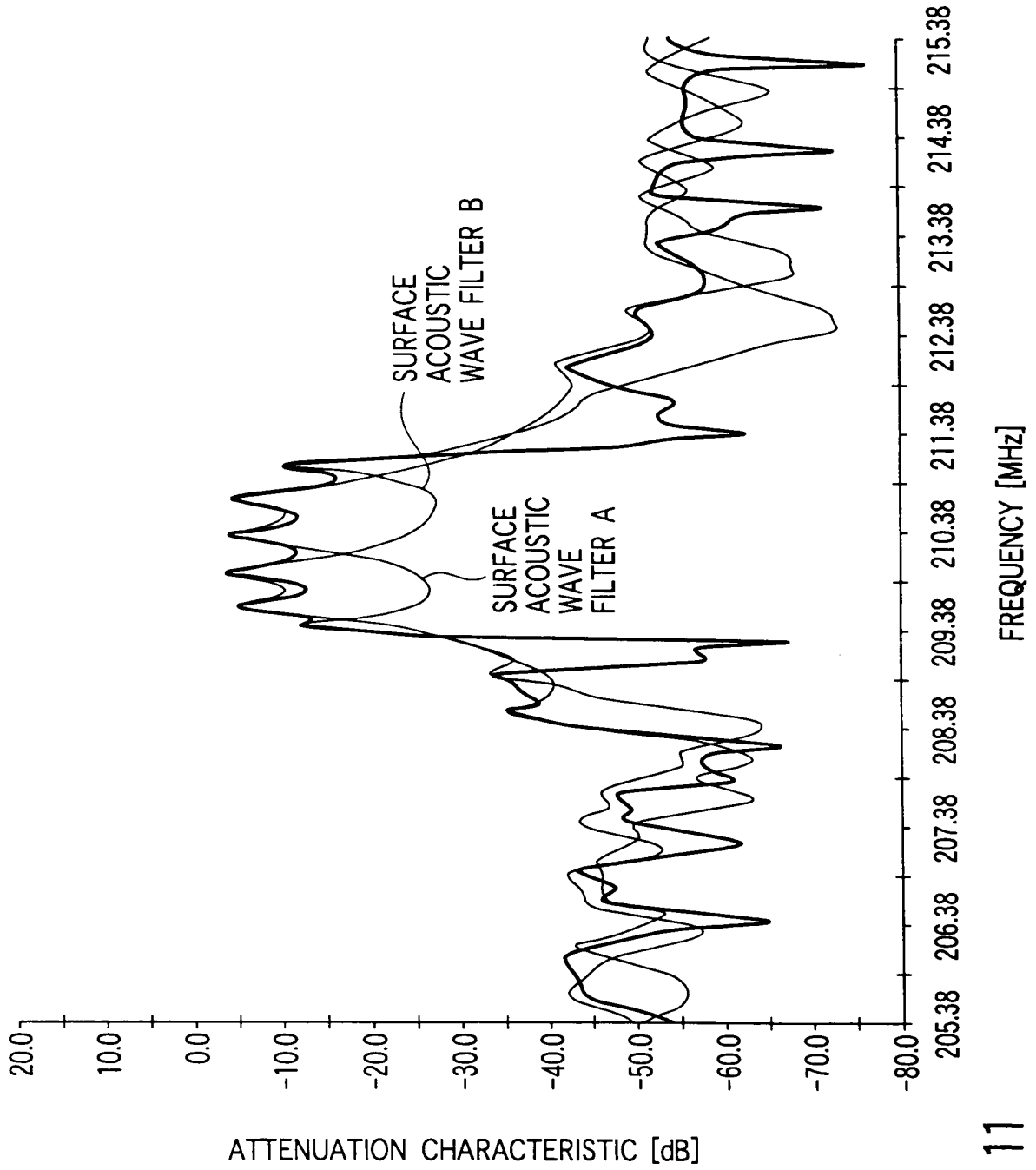

FIG. 11

208526US-2S CONT

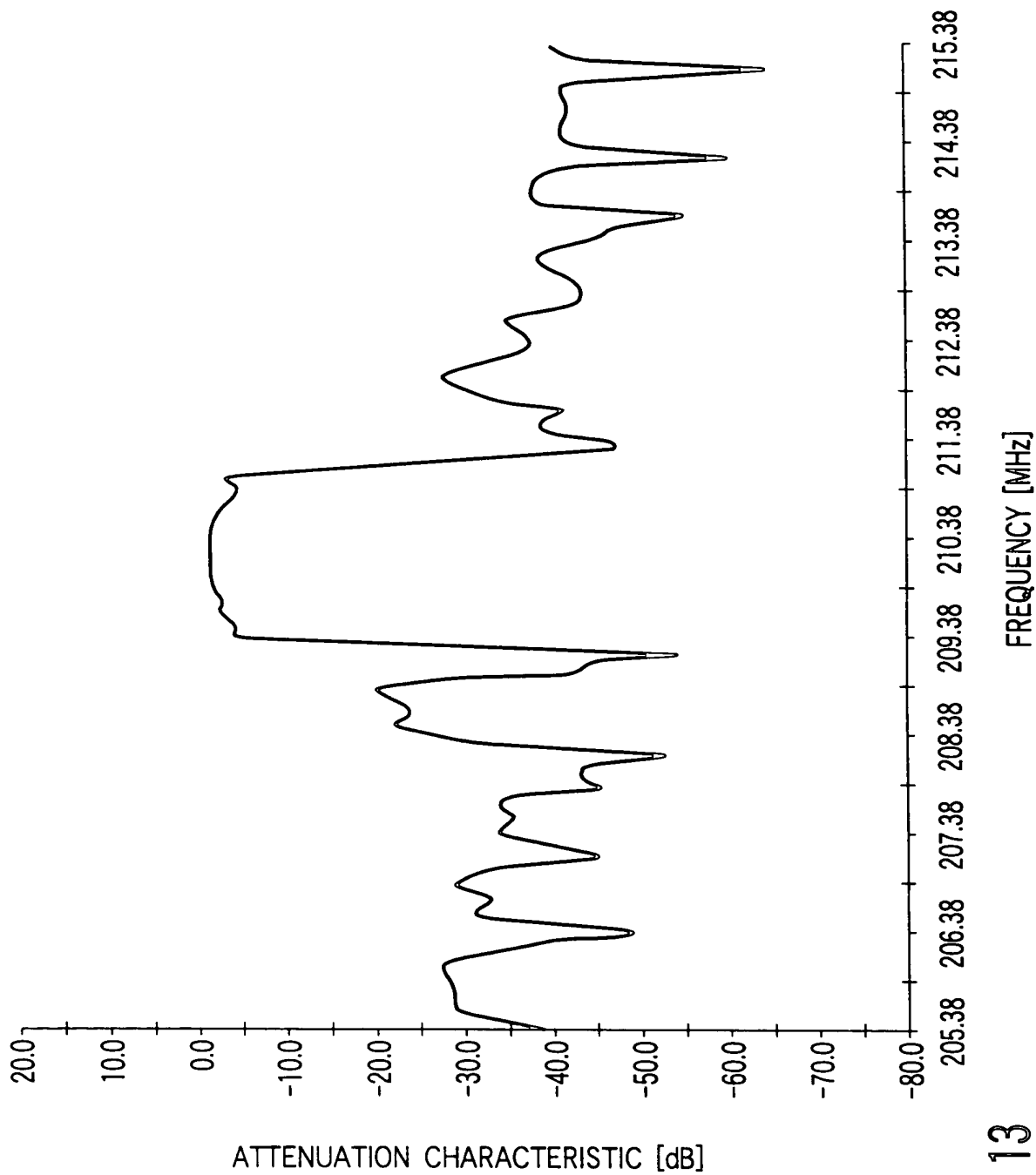

FIG. 13

208526US-2S CONT

107930 6867660

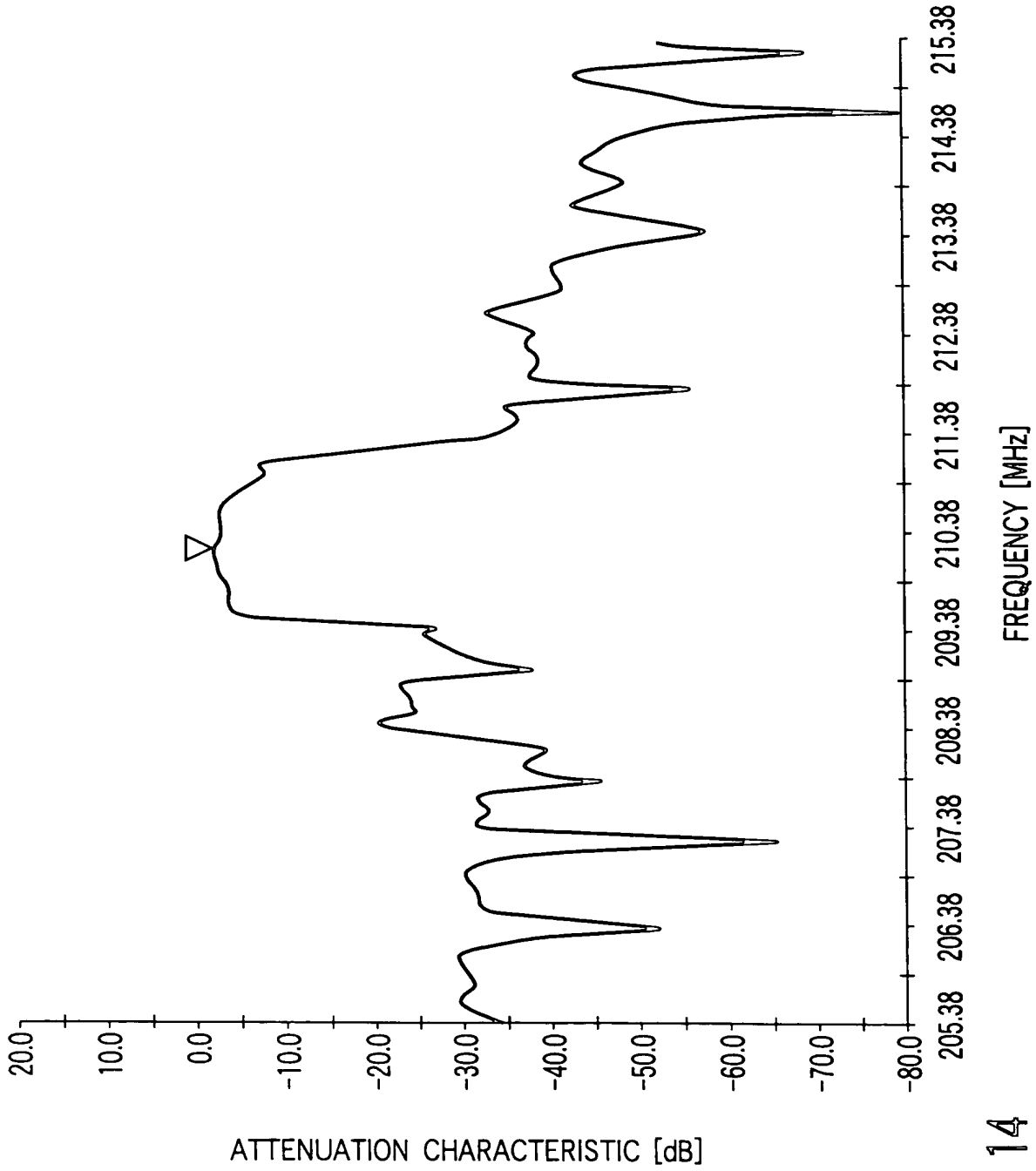

FIG. 14